

Harper Counter Table

Part # C-HARPER5 XX-XX

20-0921

PARTS

A: Table top
 B: Leg
 C: Nut (x8 5/16")
 D: Washer (x8 5/16")
 E: Washer (x8 5/16")
 F: Wrench

1

REMOVE CAPS

X4

X4

2











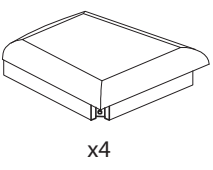

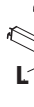

Do not over tighten.
 Do not use power tools to assemble.

Harper Counter Stool

Part # C-HARPER5 XXXX

20-0921

PARTS													TOOLS
													
A x4	B x4	C x4	D L x4	E x4	F x16 (1/4 x 75)	G x8 (1/4 x 40)	H x24	I x40 (5/16")	J x40 (5/16")	K x40 (5/16")	L	M	⊕

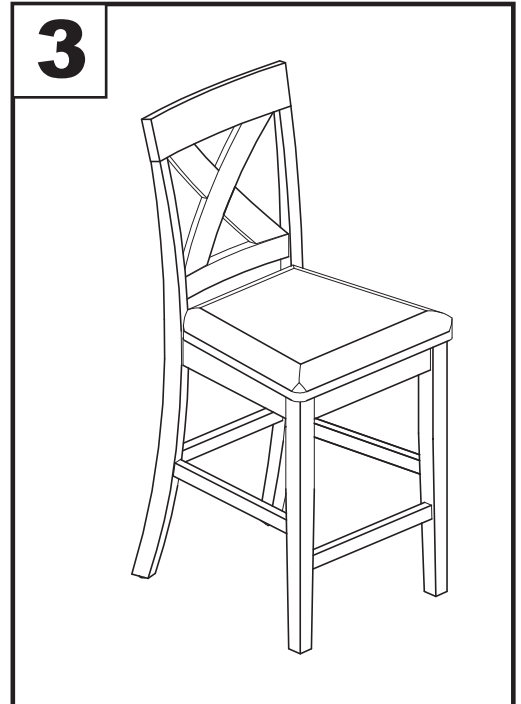
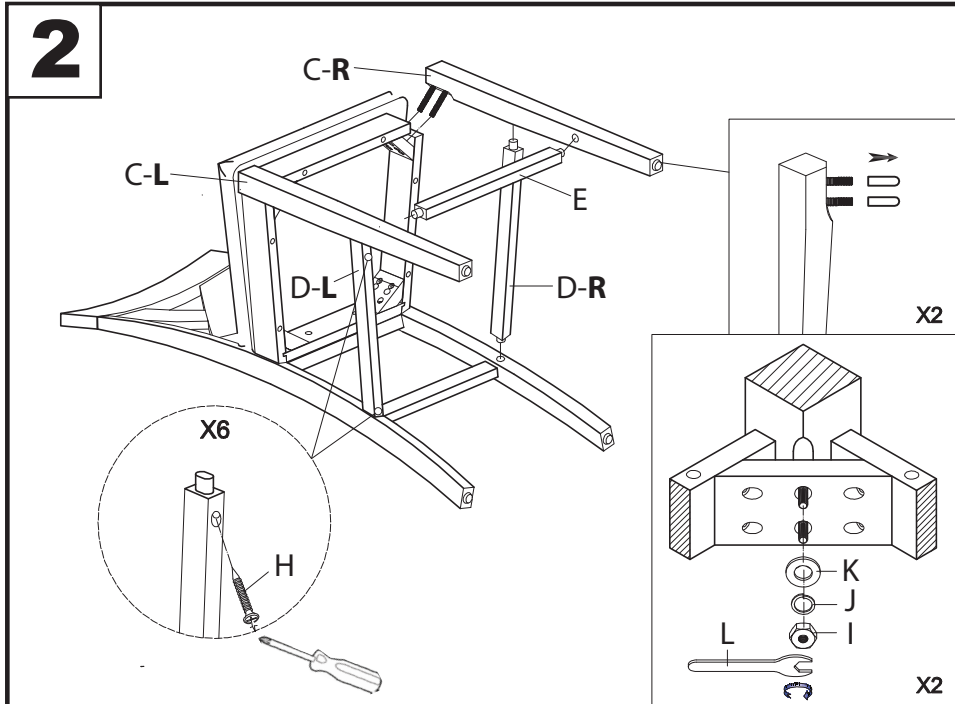
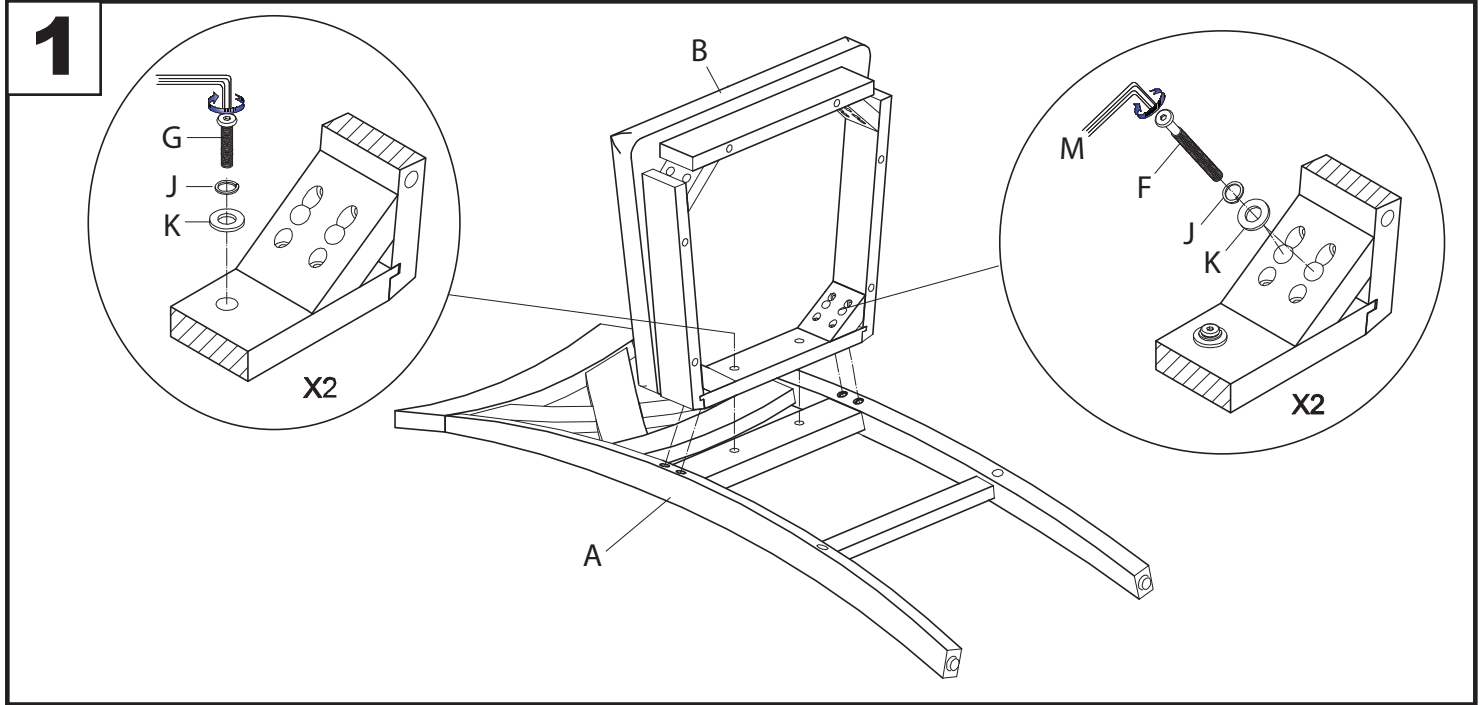

Do not over tighten.
Do not use power tools to assemble.